



SPYDR 2p47 EU

SPYDR 2p is a full-cycle top-lighting solution for commercial cannabis cultivation, with the power to scale from vegetative growth to higher light intensities in bloom. For optimal results, we recommend SPYDR 2p deployed in environments with CO₂ supplementation between 800-1400 ppm in reproductive growth stage due to high PPFD levels.

FLUENCE

BY OSRAM

SPYDR 2p47 EU

FLUENCE
BY OSRAM

SPECIFICATIONS

| | |
|---------------------------------|--|
| Light Source | LED |
| Spectrum | PhysioSpec Indoor™ |
| Light Output PPF | 1550 µmol/s |
| Efficacy | 2.45 µmol/J @ 230V AC |
| AC Input Power | 632W @ 230V AC |
| AC Input Voltage | 120-277V AC, 347-480V AC, 50/60Hz |
| Light Distribution | 120° |
| Mounting Height | 6" - 12" (15.2-30.5cm) Above Canopy |
| Thermal Management | Passive |
| Max. Ambient Temperature | 95°F / 35°C |
| Dimming | 10 V-Source |
| Total Harmonic Distortion (THD) | < 10% |
| Lifetime | L90: > 50,000hrs |
| IP Rating | IP66 |
| Certifications | CE, UL 8800, UL 1598 Wet Location, DLC |
| Warranty | 5 Year Standard Warranty |

NOMINAL ELECTRICAL AC INPUT*

| AC VOLTAGE | 120V | 208V | 230V | 277V | 347V | 400V | 480V |
|--------------|--------|--------|--------|--------|--------|--------|--------|
| AC Current | 5.42 A | 3.05 A | 2.75 A | 2.27 A | 1.87 A | 1.62 A | 1.34 A |
| AC Power | 650 W | 634 W | 632 W | 629 W | 648 W | 647 W | 646 W |
| Power Factor | 0.997 | 0.99 | 0.989 | 0.979 | 0.995 | 0.99 | 0.974 |

* At 77°F (25°C) ambient temperature

SPECTRA

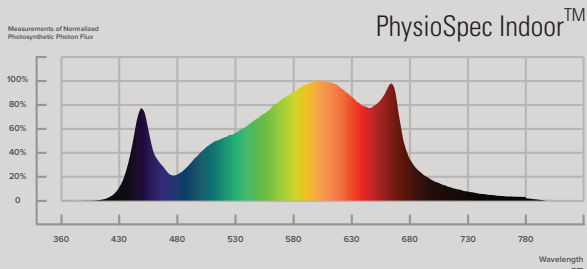

| FAMILY | MODEL | SPECTRUM | INPUT VOLTAGE | AC POWER CORD |
|--------|---------------------|----------------------|--------------------------|-----------------------------------|
| SR | SPYDR 2p 2p 47"x43" | I PhysioSpec Indoor™ | 2 120-277V 4 347-480V | 06 6ft (1.83m) 15 15ft (4.57m) |

| AC PLUG TYPE | DC EXT. CORD | MOUNTING HARDWARE | PACKAGING |
|-------------------|-----------------------------------|--------------------------|------------------------|
| TFP Schuko Type F | 00 None | W Waterfall Mounts | S Single Pack |
| VPP VDE Pigtail | 03 3 ft (.91m) 06 6 ft (1.83m) | S Solid-Decking Mounts | B15 Bulk Pack (15 QTY) |
| | | M 2-Point Hanging Lances | |
| | | A Adjustable Hanging Kit | |
| | | L Long V Mounts | |

*Please contact sales for more mounting options

DIMENSIONS

| Part | Length | Width | Height | Weight |
|----------------------------|----------------|-----------------|--------------|-------------------|
| SPYDR 2p 47" Light Fixture | 47" / 1194mm | 42.80" / 1087mm | 1.26" / 32mm | 16.7 lbs / 7.6 kg |
| PSE Power Supply 632W AC | 21.87" / 555mm | 6.24" / 159mm | 2.88" / 73mm | 11.0 lbs / 5.0 kg |

[TOP VIEW]

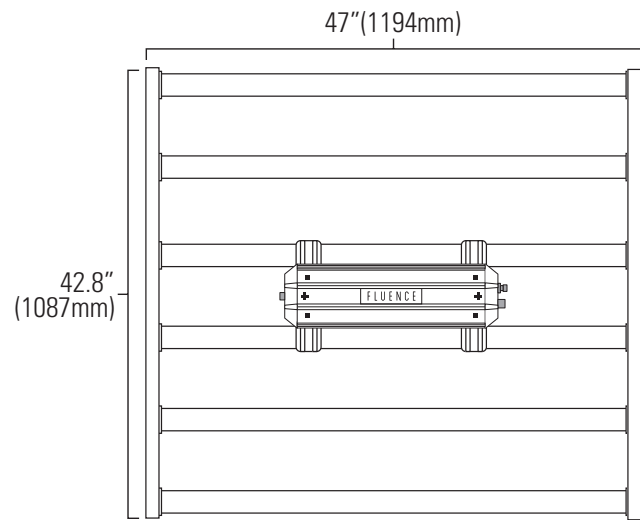

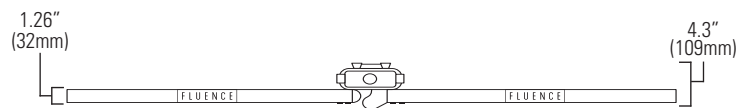

[SIDE VIEW]

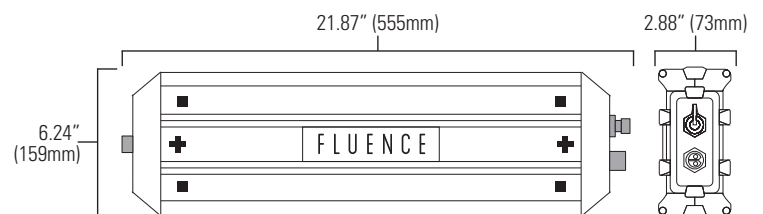

[PSE POWER SUPPLY]



Contact **FLUENCE** 
info@fluencebioengineering.com 
www.fluence.science/SPYDR 

© Copyright 2020 Fluence Bioengineering 2020-02
 Subject to change without notice, Tolerance ±10%
 Horticultural lighting | Not suitable for household illumination.